

Sculpture Park

The Sculpture Park is situated across the University Campus. There are 350 acres of attractive parkland open to everyone to enjoy art, architecture and the natural environment. Curated by the Sainsbury Centre, sculpture is selected to complement the landscape and listed built environment. There are formal gardens adjacent to the Sainsbury Centre, dense urban modernist architecture and areas of tranquillity along the Yare river valley. As well as great art, there is architecture by leading architects such as Foster, Lasdun and Mather. The park is also home for our resident population of wild rabbits and habitats for rare and endangered species. There is a wide range of fauna and flora including a number of remarkable ancient oaks. As well as works by Moore, Gormley and Frink, there are new works by Laurence Edwards, Cristina Iglesias, John Davies and Phillip King.

Sculpture

Two piece reclining figure, No.3, 1961 **1**
Henry Moore (1898–1986)
Bronze
Object number: L.06
On long loan from Tate
Location: **North side of the Sainsbury Centre**

Moore compared his reclining figures to landscapes, saying 'Knees and breasts are mountains'.

Celosía XI (Hafsa Bint Al-Hayy), 2006 **2**
Cristina Iglesias (b.1956)
Stoneware and metal structure
Object number: L.154
On loan from the artist, in association with Marian Goodman Gallery
Location: **West end garden of the Sainsbury Centre**

These terracotta screens mimic the latticed windows in Arab architecture. Iglesias co-opts their traditional geometric patterns by embedding words into the screens, incorporating a love poem by Hafsa bint al-Hayy (c.1135–90), one of the most renowned Andalusian poets.

Vegetation Room III, 2005 **3**
Cristina Iglesias (b.1956)
Bronze powder, resin, fiberglass and sand
Object number: L.153
On loan from the artist, in association with Marian Goodman Gallery
Location: **West end garden of the Sainsbury Centre**

A recipient of Spain's National Visual Arts Award in 1999, Iglesias' work combines artificial materials and industrial techniques with natural and organic forms. Her vegetation rooms turn the experience of walking into a building inside out: you step into nature rather than away from it.

Head, 1997 **4**
John Davies (b.1946)
Bronze
Object number: L.159
On loan courtesy of the artist.
Location: **West end garden of the Sainsbury Centre**

In the late 1990's John Davies introduced monumental heads to his practice to explore how the human figure may be perceived and how one can relate to it. This head has serene expression at once in harmony and at peace in its natural surroundings.

Sun's Roots II, 2008 **5**
Phillip King (b.1934)
Painted steel
On loan to the Sainsbury Centre from the artist
Supported by Ivor Braka Ltd and Thomas Dane Gallery
Object number: L.158
Location: **South side of the Sainsbury Centre**

Concerned with the relationship between the sun and the earth, this striking, brightly painted sculpture demonstrates Phillip King's longstanding commitment to exploring the dynamic between surface, structure, colour and form.

Model of the Monument to the Third International, 1919–20 **6**
(design); 2011 (reconstruction)
Vladimir Tatlin (1885–1953)
Reconstruction by Jeremy Dixon and Chris Milan of Dixon Jones Steel and composites
Collection of the Sainsbury Centre
Object number: 31504
Donated by the Royal Academy of Arts, 2012
Location: **South side of the Sainsbury Centre**

Tatlin is famous for his unrealised Tower that was intended to be 400m tall. This large-scale model created by Jeremy Dixon is at a scale of 1:40.

Crouching Beast II, 1990 **7**
Lynn Chadwick (1914–2003)
Welded stainless steel
Object number: L.91
On loan from the Estate of Lynn Chadwick, in association with Blain|Southern
Location: **East end garden of the Sainsbury Centre**

Beast Alerted I, 1990 **8**
Lynn Chadwick (1914–2003)
Welded stainless steel
Object number: L.93
On loan from the Estate of Lynn Chadwick, in association with Blain|Southern
Location: **East end garden of the Sainsbury Centre**

Lion I, 1990 **9**
Lynn Chadwick (1914–2003)
Welded stainless steel
Object number: L.92
On loan from the Estate of Lynn Chadwick, in association with Blain|Southern
Location: **East end garden of the Sainsbury Centre**

Initially trained as an architect, Chadwick became one of the most important sculptors of the twentieth century. The *Beasts* were among the final works he made, continuing the animal theme he established early in his career.

Reclining Figure, 1956–62 **10**
Henry Moore (1898–1986)
Bronze
Collection of the Sainsbury Centre
Object number: 85
Location: **East end garden of the Sainsbury Centre**

The reclining figure offered Moore endless possibilities for experimentation. This figure shows the influence of Picasso and Surrealism.

ANOTHER TIME VIII, 2007 **13**
Antony Gormley (b.1950)
Cast iron
Object number: L.81
On long loan from the artist
Location: **Roof of biology department (teaching wall)**

ANOTHER TIME IV, 2007 **16**
Antony Gormley (b.1950)
Cast iron
Object number: L.80
On long loan from the artist
Location: **Elevated walkway of the UEA Central Library**

ANOTHER TIME II, 2007 **17**
Antony Gormley (b.1950)
Cast iron
Object number: L.79
On long loan from the artist
Location: **Roof of the UEA Central Library**

Gormley selected locations around the campus to present three casts of his own body. Thought-provoking and uncanny, they offer spectacle and surprise. Gormley is best known in the UK for his monumental sculpture, *Angel of the North*.

Mirage I and II, 1969 **12**
Elisabeth Frink (1930–1993)
Bronze
Object numbers: L.106 and L.107
On loan from the Elisabeth Frink Estate and Archive
Location: **West end of the Broad**

Inspired by seeing heat hazes and flamingos in the South of France, these creatures are part-bird, part-human. Frink described the visions as 'sort of birds, or it could be a person, or a tree. Any of those make this extraordinary stalking shape that shimmers across'.

Proximity, 2006 **14**
Ian Tyson (b.1933)
Painted steel
Collection of the Sainsbury Centre
Object number: 31418
Location: **In front of Ziggurats**

The first site-specific work in the Sculpture Park, *Proximity* offers a view to the Ziggurats and echoes their form.

Please look after yourself and the artworks, do not touch or climb on the sculptures.

SAINSBURY CENTRE OPENING TIMES
Tuesday–Friday, 9am–6pm
Exhibitions open from 10am
Saturday–Sunday, 10am–5pm
Closed on Mondays and Bank Holidays.
See sainsburycentre.ac.uk for exceptions.

ADMISSION
Free entry to the Sculpture Park and the Sainsbury Centre collection. Please see website for details of temporary exhibition prices.
For information **01603 593199**
scva@uea.ac.uk

The Sculpture Park is supported by

Simon Blakey

HUDSON Architects



Extrapolation, 1982 **15**
Liliane Lijn (b.1939)
Stainless steel
Object number: L.08
On long loan from Norfolk County Council
Location: **Behind the UEA Central Library**

Lijn compared these ascending steel plates to the pages of a book as the sculpture was created for the Norwich Central Library. Lijn often works with materials that reflect or refract light.

Variations on a Square, 1964 **18**
Henry H. Clyne (b.1930)
Brass, brazed copper sheet, steel
Collection of the Sainsbury Centre
Object number: 41289
Location: **Behind the UEA Central Library**

Clyne's interlocking partial cubes reflect UEA's Brutalist campus and show the influence of the Bauhaus.

One for Bristol, 1968 **19**
John Hoskin (1921–90)
Painted steel and aluminium
Collection of the Sainsbury Centre
Object number: 41399
Location: **Behind the Music Centre**

Hoskin began making figurative sculpture in the early 1950s before turning to his abstract colourful style of the 1960s.

Man of Stones, 2019 **20**
Laurence Edwards (b.1967)
Bronze
Object number: L.114
Long loan from a private collection
Location: **South side of the Broad**

Edwards' site-specific sculpture is concerned with our relationship to the natural environment. Situated between the river Yare and the Broad, it is a deceptively remote and wild place. Edwards collected source material from the site, which he incorporated into his sculpture.

PARKING
There is a dedicated car park for Sainsbury Centre Visitors (P7) opposite the Sainsbury Centre:
• Tuesday–Sunday: FREE, permit required. On arrival report to Gallery Reception and obtain permit. Car park is opened at 9am and is locked 10 minutes after gallery closing time.

• At other time please use alternative University parking.

ACCESSIBILITY
The Sculpture Park is accessible with the exception of **11**, **12** and **20**. These works are not easily reached by wheelchair.

Architecture

Constable Terrace **21**
Rick Mather (1937–2013)
Project date: 1989; Construction: 1991–93

This student housing was built as part of Mather's masterplan for the UEA campus from 1988–94, his first large new-build project.

Sainsbury Centre for Visual Arts **22**
Norman Foster (b.1935)
Project date: 1974; Construction: 1975–78

The Sainsbury Centre (Foster's first public building) was a new type of museum in which gallery, social space and teaching were all intergrated in an open plan building.

Ziggurats **23**
Denys Lasdun (1914–2001)
Project date: 1962; Construction: 1964–68
This iconic student accommodation takes its name, Ziggurats, from ancient Mesopotamian structures.

Environment

Within just a few metres of the strikingly modern Sainsbury Centre is an ancient oak tree that is over 400 years old. This living sculpture supports an ecosystem and a habitat rich in biodiversity. Oak trees support more life forms than any other native tree. **11**

SAINSBURY CENTRE

SCULPTURE PARK

at the Sainsbury Centre and University of East Anglia

£1 (Suggested donation)

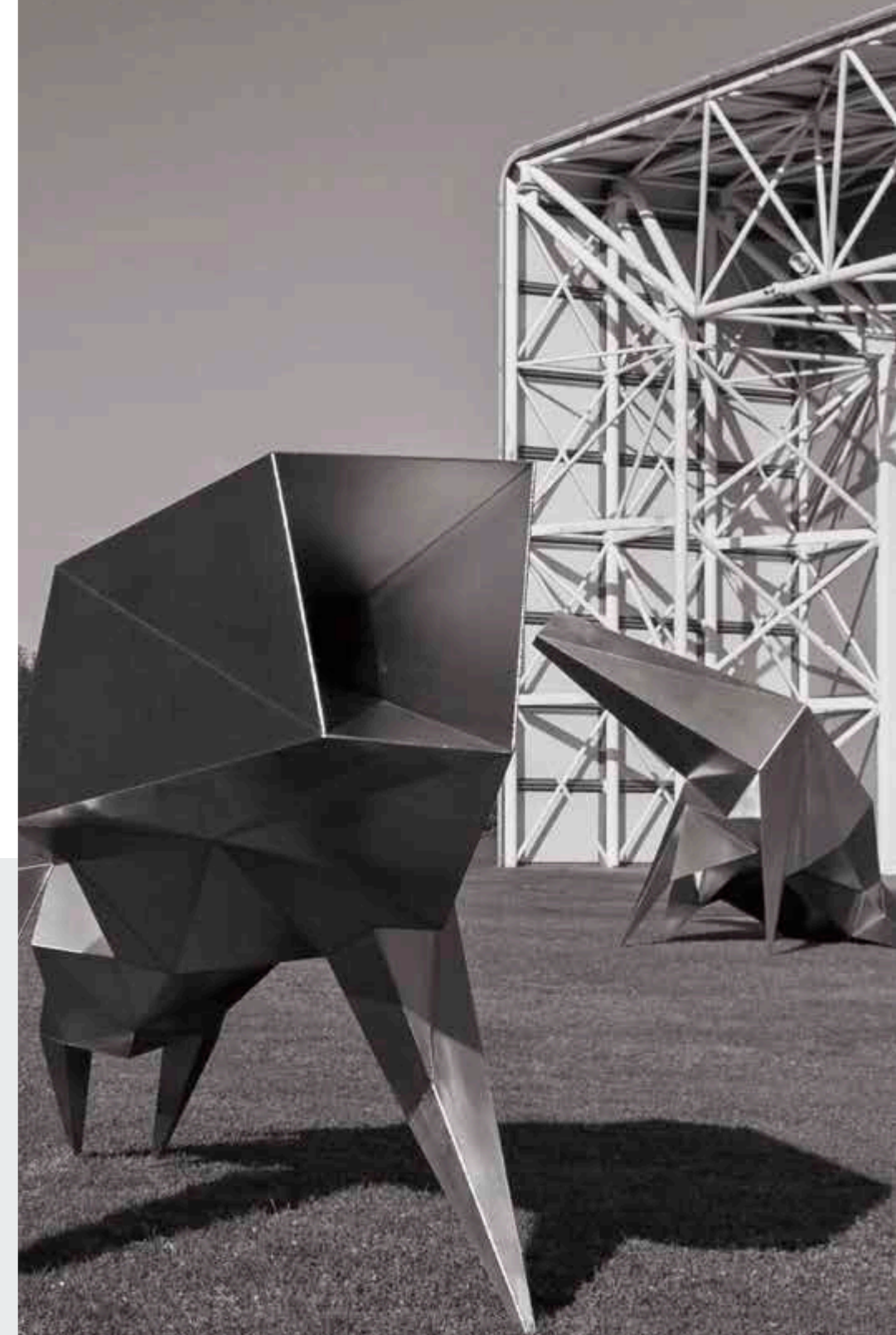

Front: Lynn Chadwick *Beasts* at the Sainsbury Centre. Courtesy of the Estate of Lynn Chadwick and Blain|Southern. Photo Andy Crouch

The Sainsbury Centre is supported by



Revised September 2020



1 HENRY MOORE
Two Piece Reclining Figure No. 3, 1961

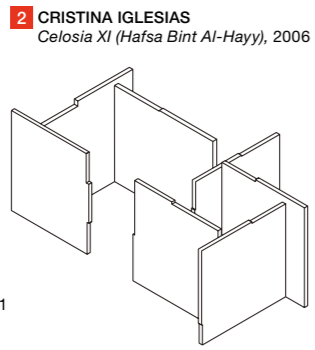

2 CRISTINA IGLESIAS
Celosia XI (Hafsa Bint Al-Hayy), 2006

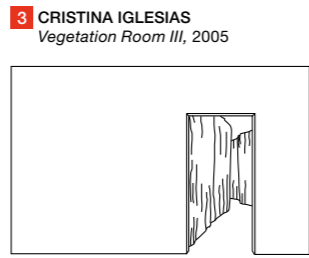

3 CRISTINA IGLESIAS
Vegetation Room III, 2005

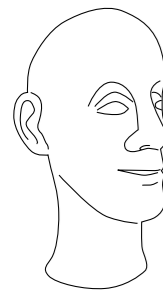

4 JOHN DAVIES
Head, 1997

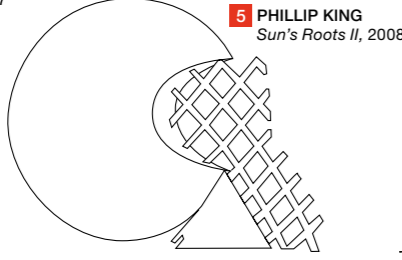

5 PHILLIP KING
Sun's Roots II, 2008

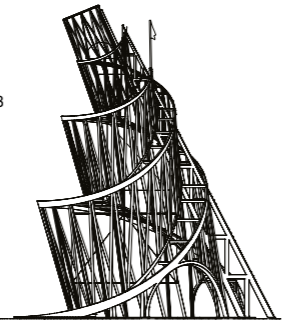

6 VLADIMIR TATLIN
Model of the Monument to the
Third International, 1919-20 (2011)

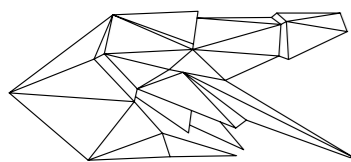

7 LYNN CHADWICK
Crouching Beast II, 1990

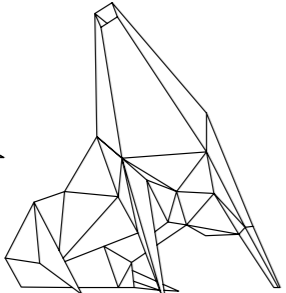

8 LYNN CHADWICK
Beast Alerted I, 1990

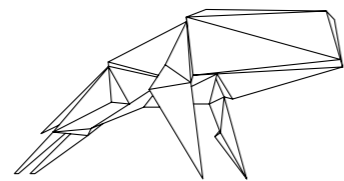

9 LYNN CHADWICK
Lion I, 1990

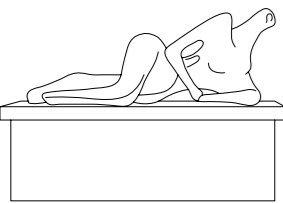

10 HENRY MOORE
Reclining Figure, 1956-62

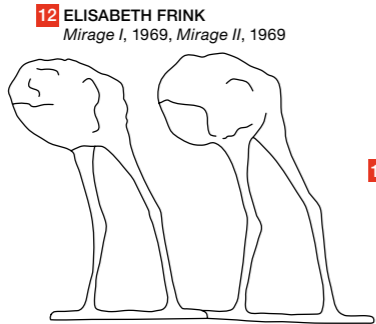

12 ELISABETH FRINK
Mirage I, 1969, Mirage II, 1969

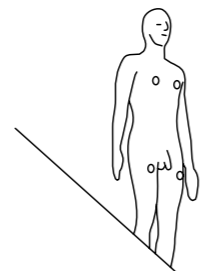

13 ANTONY GORMLEY
ANOTHER TIME VIII, 2007

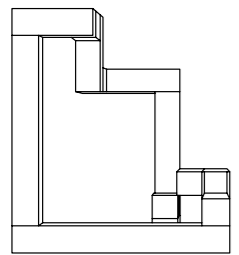

14 IAN TYSON
Proximity, 2006

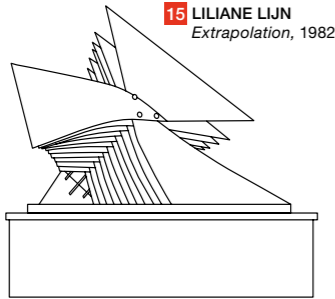

15 LILIANE LIJN
Extrapolation, 1982

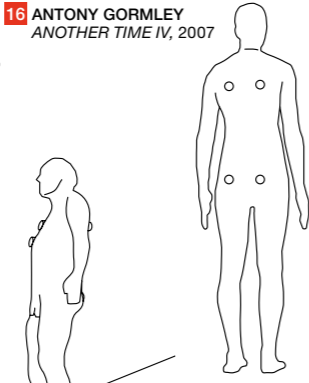

16 ANTONY GORMLEY
ANOTHER TIME IV, 2007

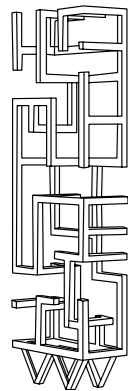

18 HENRY H. CLYNE
Variations on a Square, 1964

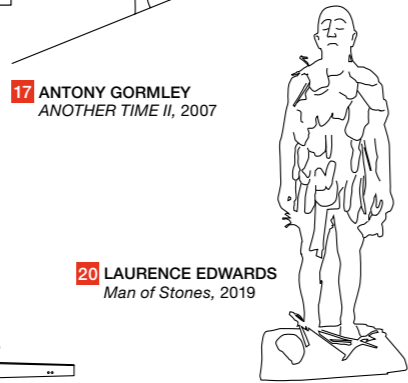

17 ANTONY GORMLEY
ANOTHER TIME II, 2007

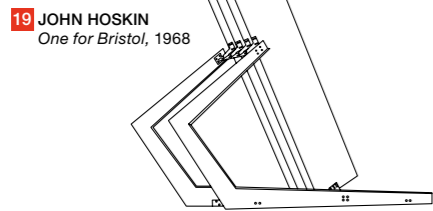

19 JOHN HOSKIN
One for Bristol, 1968



20 LAURENCE EDWARDS
Man of Stones, 2019

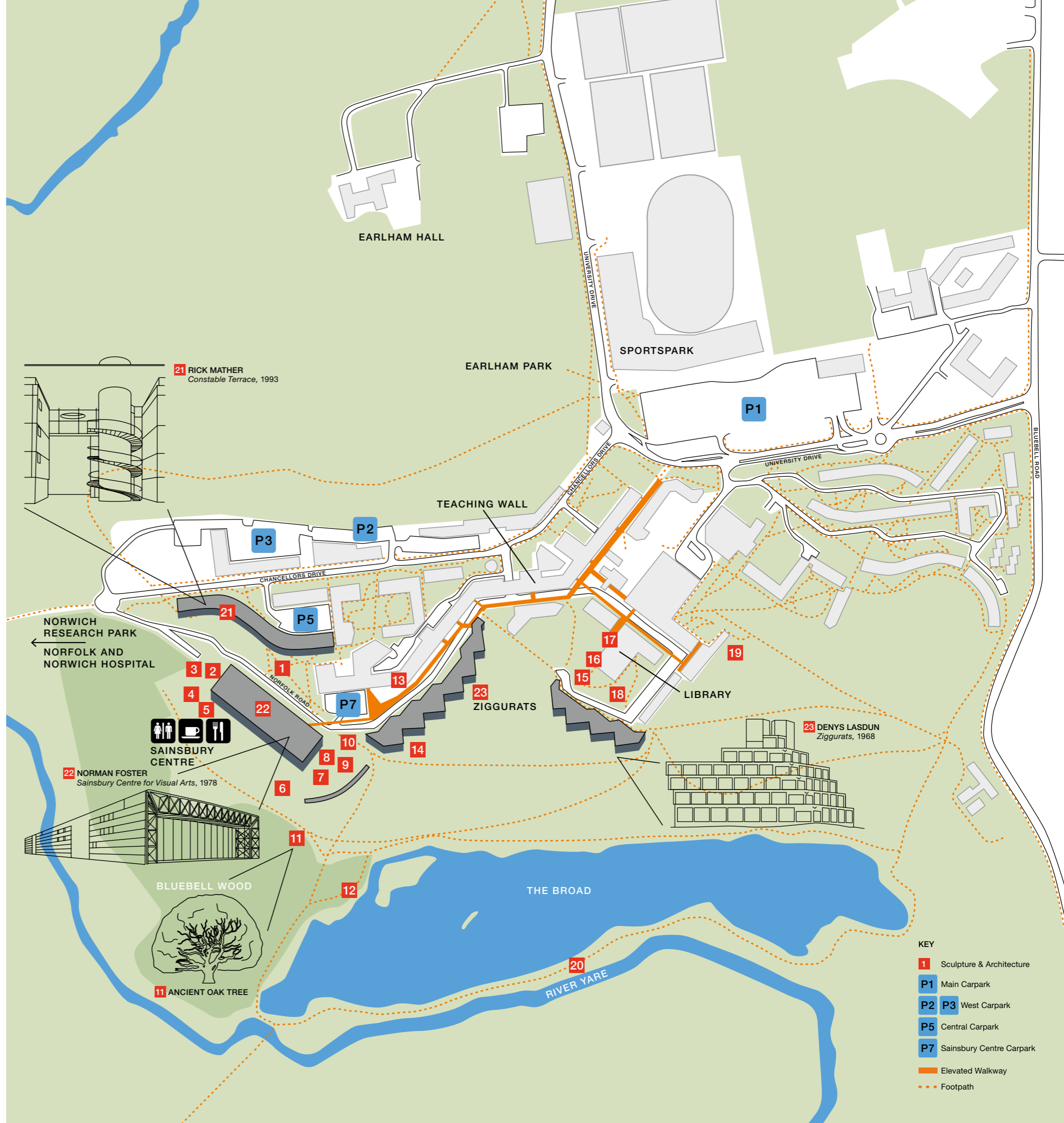

- KEY
- 1 Sculpture & Architecture
 - P1 Main Carpark
 - P2 P3 West Carpark
 - P5 Central Carpark
 - P7 Sainsbury Centre Carpark
 - Elevated Walkway
 - ... Footpath